

GuilloMax

User Manual

The GuilloMax has distinct features such as its unique structure and ease of cutting. It combines symmetry with functionality with the necessary maintenance tools stored in a convenient built in tool box, as well as parallel handles for its paper clamp and blade handle that are close to each other for easy two handed operation even by just one user. The heavy duty construction is simple yet efficient with minimal moving parts for easy maintenance. The cutting blade is extremely sharp, so several safety features are included with the machine, such as a blade handle lock, blade guard and a unique blade holder that enables the user to handle the blade without actually touching it directly.

Cutting Preparation

Place the handles for both the blade and the clamp all the way up. Doing this with the blade handle locks it in place. The blade handle lock can be released by holding down the lock release on the base of cutter while bringing down the handle.

With the blade handle in the locked position, set the paper stack against the alignment guides for the top and side of the stack. As soon as the paper stack is set under the cutting blade based on the desired position, pull the clamp handle down on the stack and secure it by pressing down on the handle to lock the stack in place. Unlock the blade handle and pull down to start cutting.

Remember to push the handle all the way up and lock it to secure the blade in a safe position when the cutter is not being used.

Parts:

1. Blade handle
2. Clamp handle
3. Top alignment guide
4. Side alignment guide
5. Cutting blade
6. Paper clamp
7. Tool box
8. Blade handle lock release
9. Cutting base
10. Blade cradle

Tools Included:

1. Blade holder
2. Spare cutting bar
3. Blade guard
4. 1/2" allen wrench
5. Philips screw driver
6. Spare screws

GuilloMax

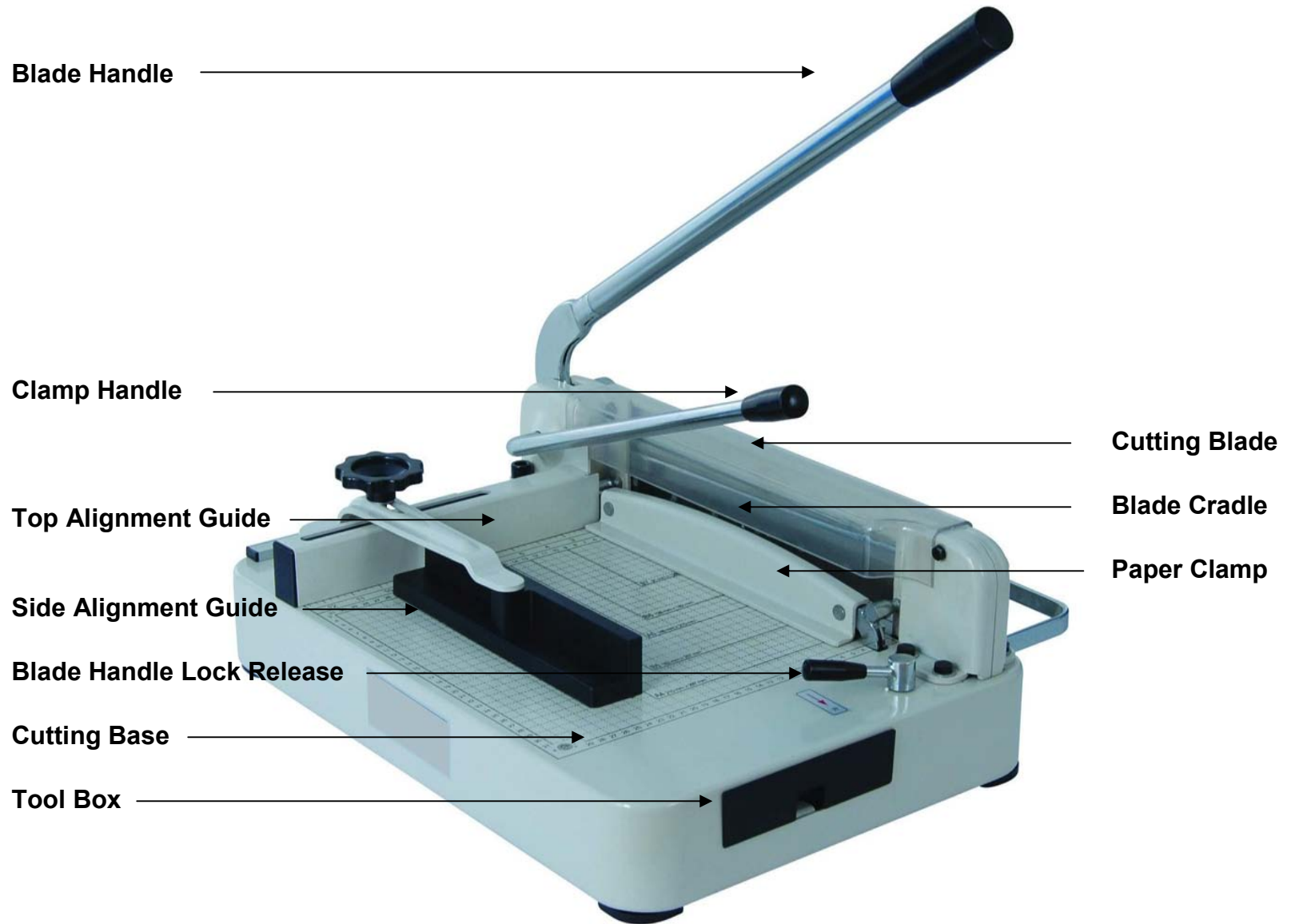

Operating Procedures



Step 1

Push the blade lever all the way up until it reaches a 90 degree angle. Stop when you hear a clicking sound. This means that the lever is locked in place.

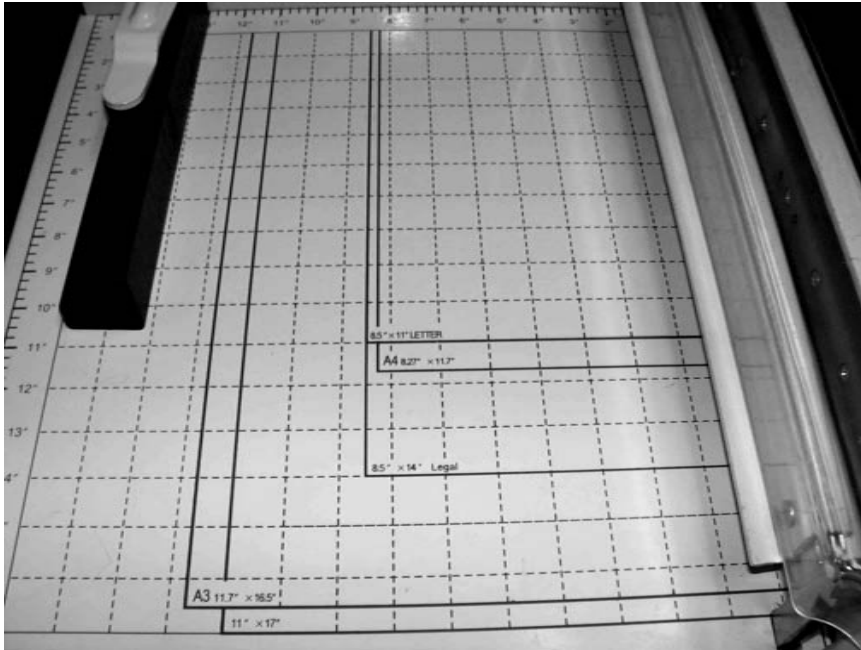

Step 2

Choose desired size that you want to cut.

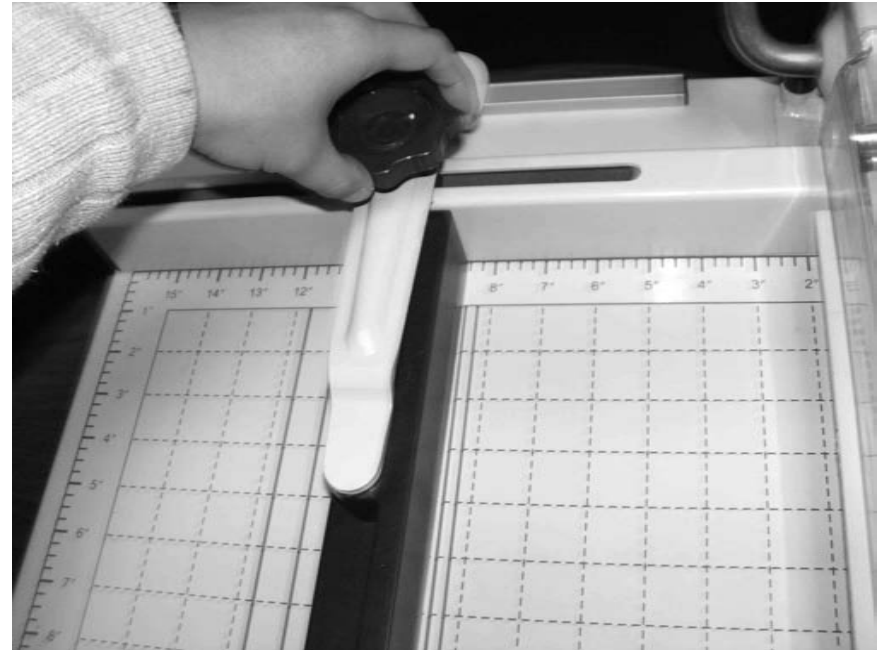

Step 3

Align bar into the chosen size and tighten the screw by turning clockwise.

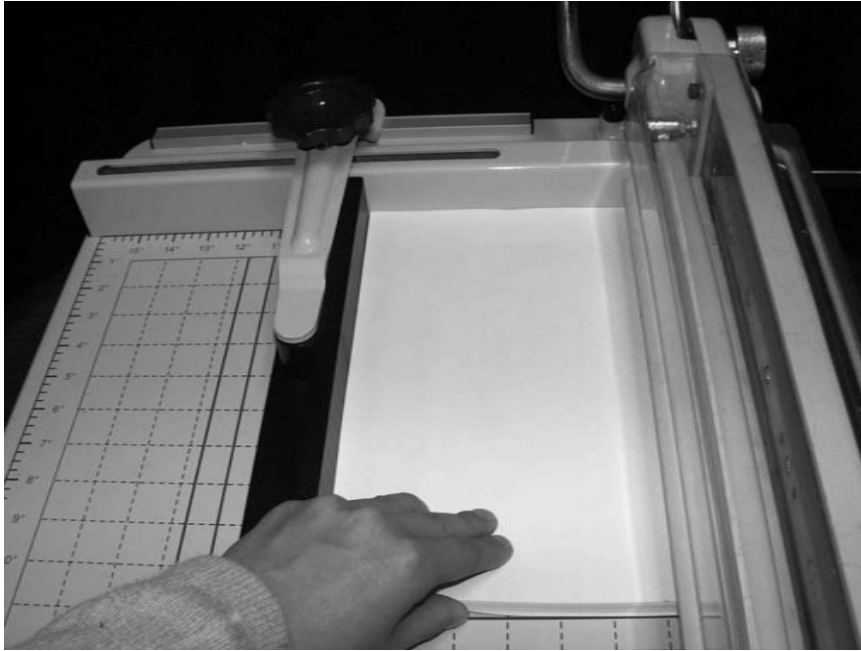

Step 4

Insert paper.

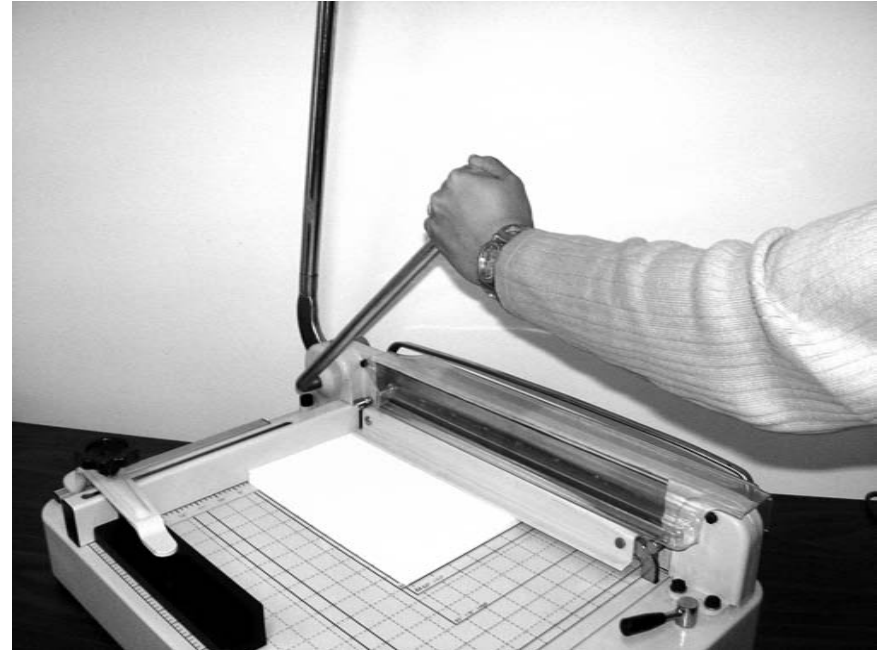

Step 5

Pull down clamp lever to lock paper in.

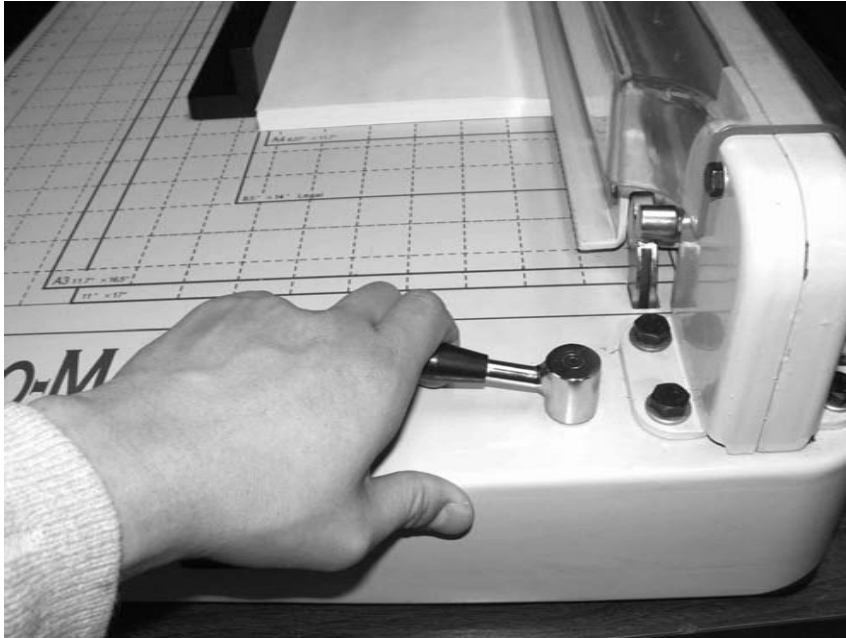

Step 6

Press and hold to release safety lock for the blade handle.

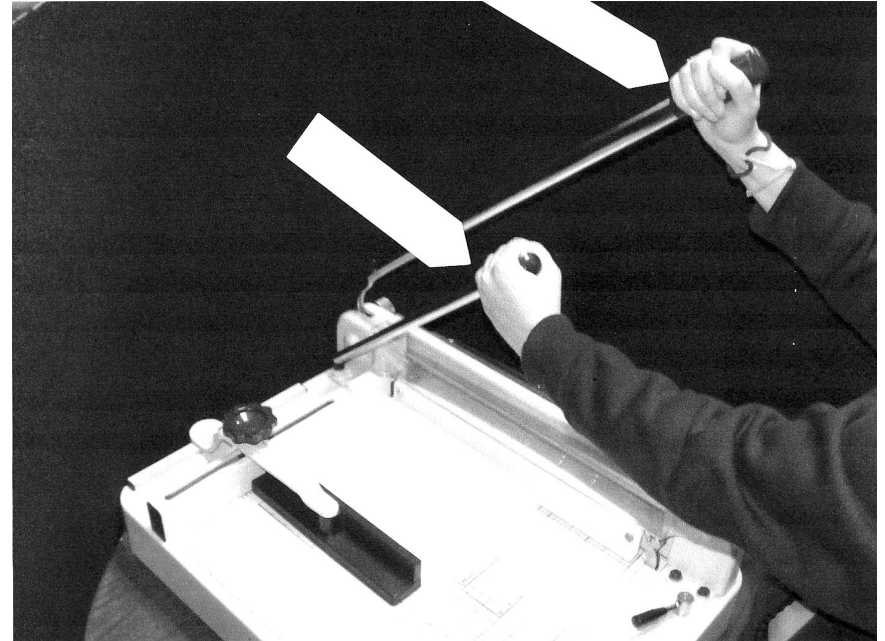

Step 7

Press the clamp lever to secure the paper before pressing down the blade handle. Make sure to lock the handle again before releasing the paper.

Changing the Cutting Stick

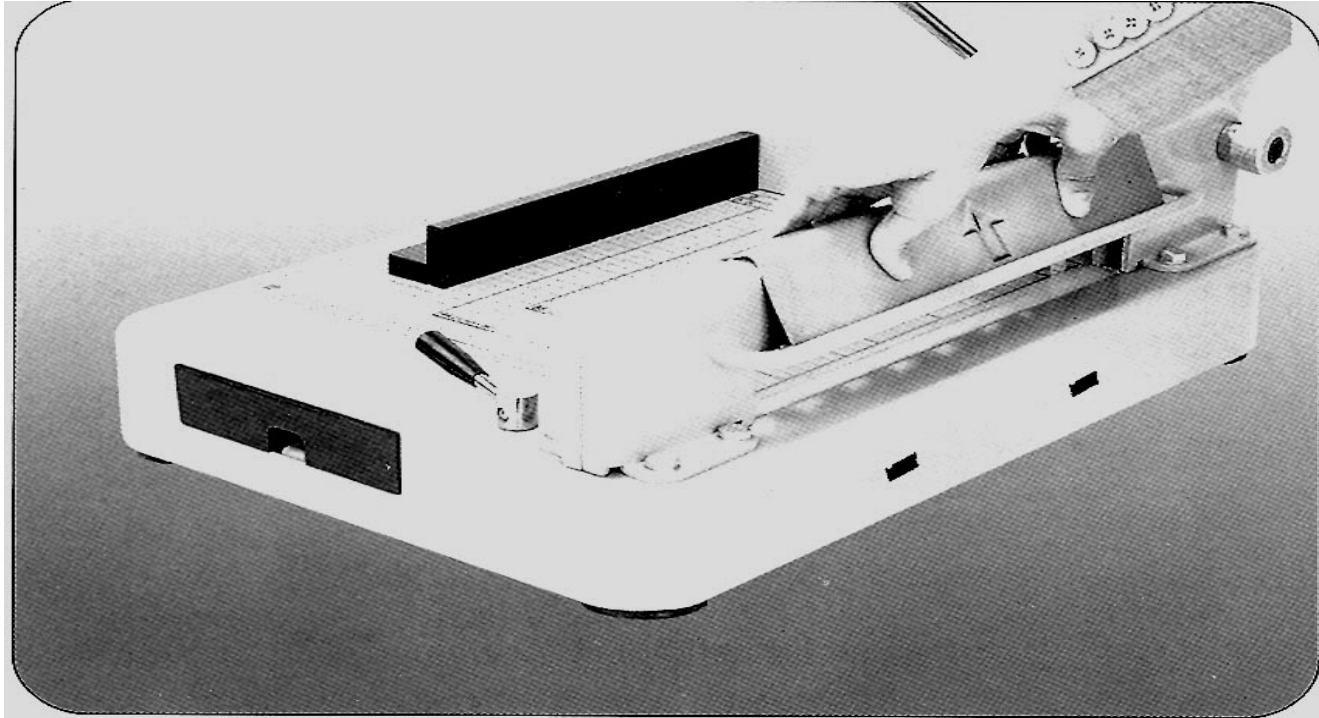

Fig 1

In order to protect the blade from undue wear, the cutter is equipped with a cutting stick that is made of hard plastic. It is positioned right under the cutting space of the blade to act as a cutting stopper preventing the blade from touching any metal part of the base. To make this stick last longer, you can rotate the stick to a new side that gets in contact with blade. The first thing to do is to install the blade guard, with the arrow pointing up, onto the blade's cradle (See Fig. 1). Hook the top part of the guard onto the cradle first and press on the bottom part until you hear a click sound. This protects whoever is changing the blade or the bar from getting accidentally cut by the exposed blade.

Changing the Cutting Stick

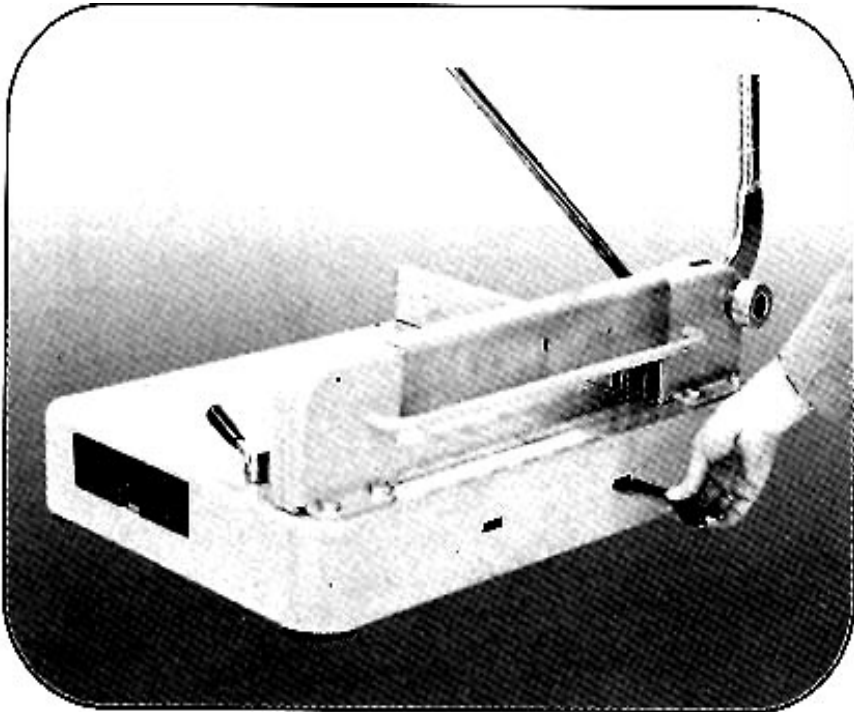

Fig 2

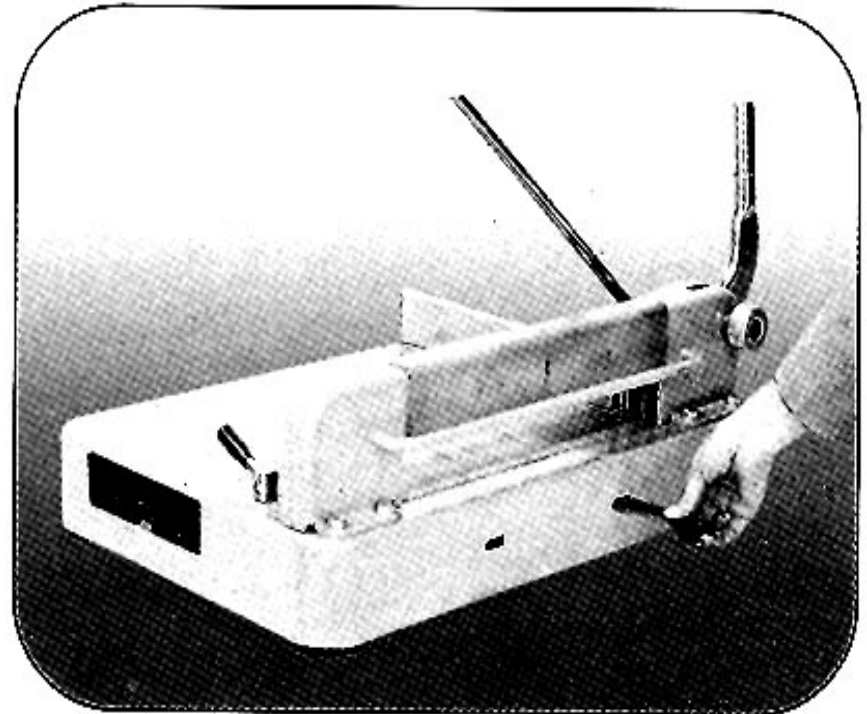

Fig 3

After installing the blade guard, take out the blade holder and insert the smaller end at about a 45 degree angle with the arch facing down into the first hole from the right side of the base. From this position, move the holder in a downward motion until the cutting bar pops out (See Fig. 2-3).

Changing the Cutting Stick

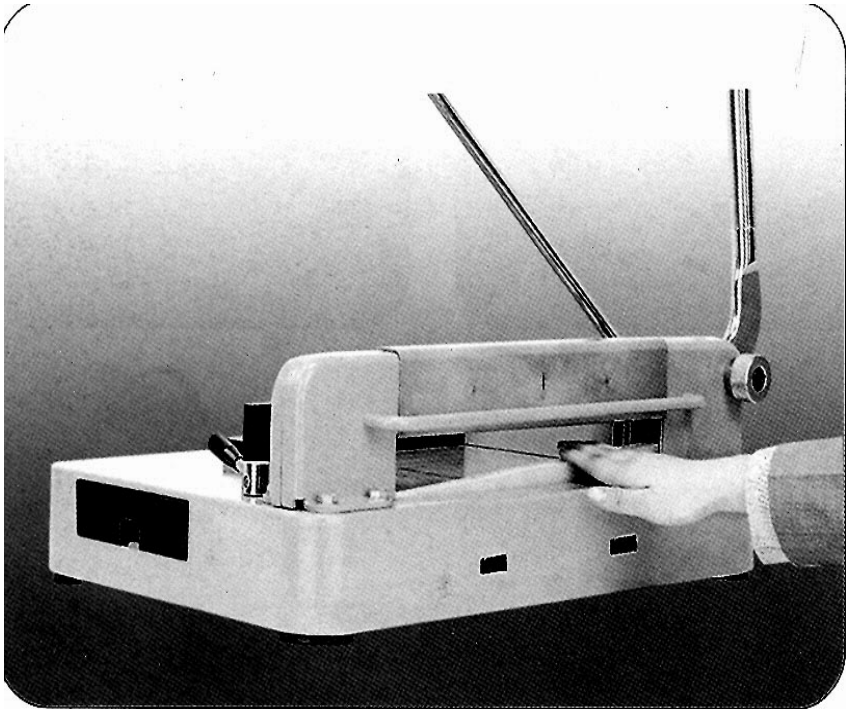

Fig 4

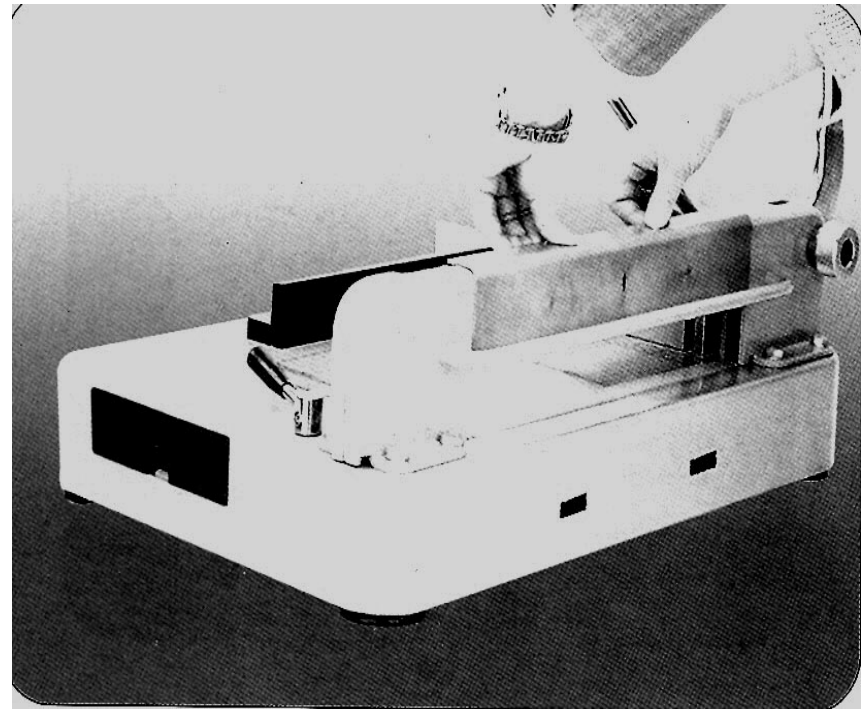

Fig 5

You can then rotate the bar 90 degrees and reinsert it into its recessed slot to change the side the meets with the blade when cutting (See Fig. 4). You can do this for all sides and on both ends of the bar. An extra bar is also provided in the tool box. To remove the blade guard, simply pull the top part backward from the cutter cradle (See Fig. 5)

Adjusting the Blade

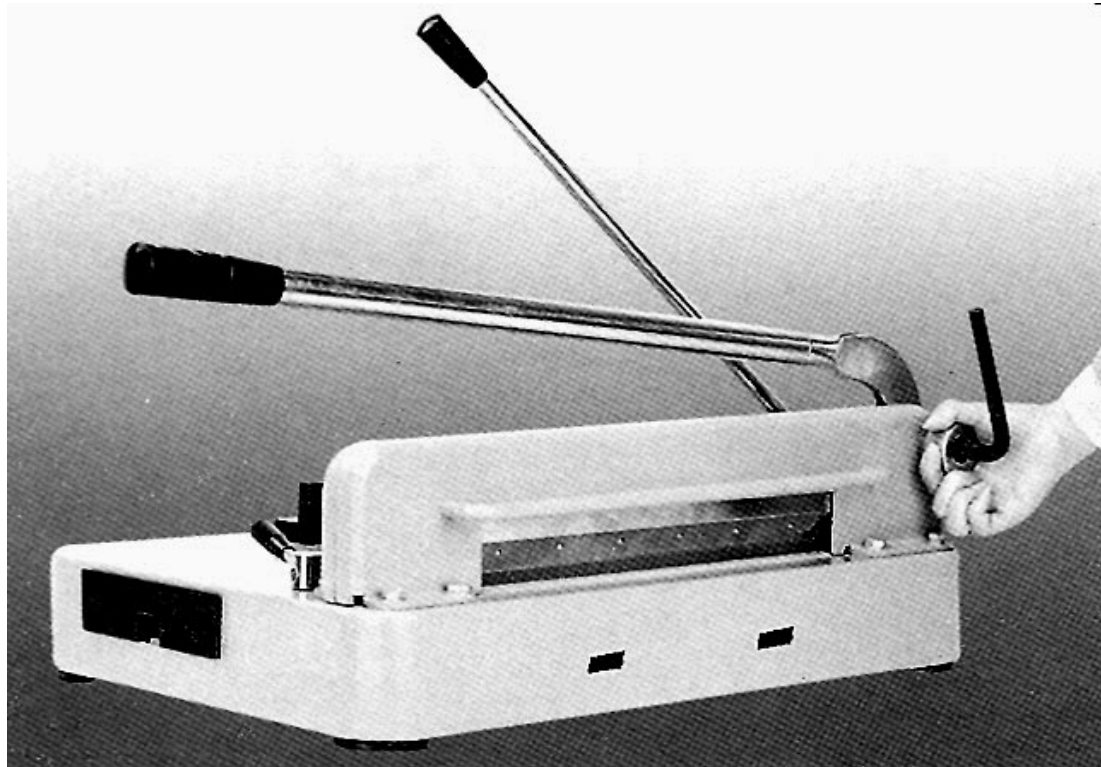

Fig 6

After changing the blade or the cutting stick, or if the blade starts to cut unevenly, you might need to adjust the balance of the blade. To do this, take out the $\frac{1}{2}$ " allen wrench and loosen the blade adjustment knob located at the right side of the cutter by the base of the blade. With the blade handle down, turn the allen wrench counter clockwise. To adjust the blade, you need to turn the knob by hand until balance is achieved. To check for balance, the blade should be resting evenly along its length on the protective cutting bar. Turn the allen wrench clockwise to relock the blade in place (See Fig. 6).

Changing the Blade

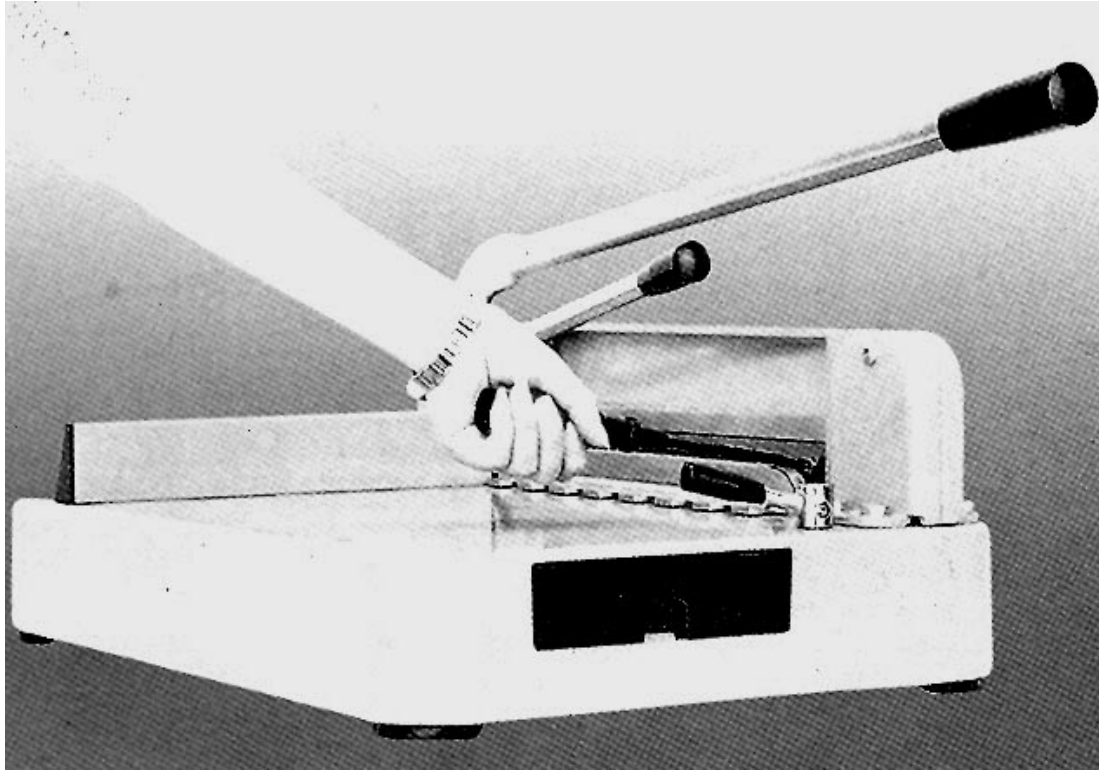

Fig 7

Change the blade whenever necessary. First, with the clamp handle up, pull the blade handle down to expose the first screw attaching the blade to its cradle (See Fig. 7).

Changing the Blade

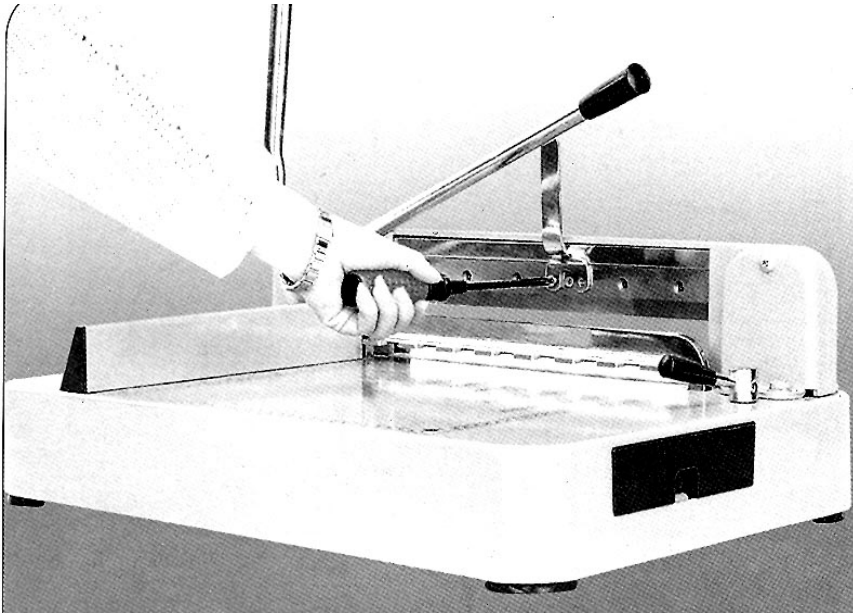

Fig 8

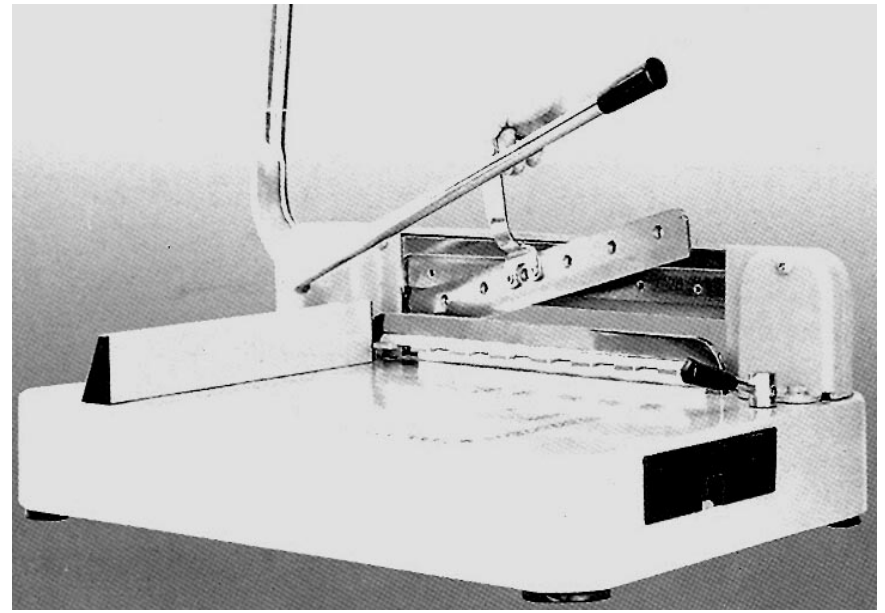

Fig 9

Remove the said screw using the Philips screwdriver. Lift the blade handle back up to its locked position and pull the clamp handle down. Using the spare screws and the Philips screwdriver, install the horned end of the blade holder to the two exposed holes in the middle of the blade. While holding the blade holder, remove all the remaining screws that attach the blade to its cradle, making sure to remove the screw in the middle of the blade last of all (See Fig. 8). To remove the uninstalled blade, slide it downwards from the front and out of the cradle (See Fig. 9).

To install a new blade, follow the instructions in reverse order, making sure each screw is tightly installed.